

Abrasive Catalog

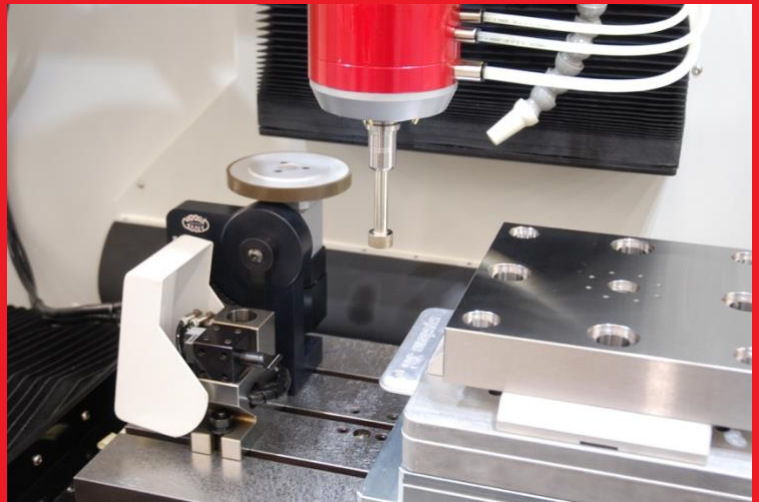

January 2018

F-1608 Rev. K

Table of Contents

Section	Title	Page Number
1.0	How to Order	4
2.0	Applications Support	4
3.0	Using Grinding Wheels Properly	5-6
4.0	Abrasive Definitions and Usage	7
4.1	Conventional Abrasive	7
4.2	Electroplated	7
4.3	ABN Super Abrasive (Gold Line)	7
4.4	CBN Super Abrasive	7
4.5	Diamond Super Abrasive	7
4.6	Resin Bond	8
4.7	Metal Bond	8
4.8	Carbide Burr	8
5.0	Wheel Chart Definitions	9
6.0	Grinding Wheel Selection	10-11
6.1	Conventional Abrasive Line	12
6.2	Gold Line Series (ABN Super Abrasive)	12
6.3	Contour Grinding Mandrel (CBN Super Abrasive)	13
6.4	Electroplated CBN and Diamond (Inch)	14
6.5	Electroplated CBN and Diamond (Metric)	15
6.6	High Speed Electroplated CBN and Diamond (Inch)	16
6.7	High Speed Electroplated CBN and Diamond (Metric)	17
6.8	Resin Bond CBN and Diamond (Inch)	18

6.9	Resin Bond CBN and Diamond (Metric)	19
6.10	Metal Bond CBN and Diamond (Inch)	20
6.11	Metal Bond CBN and Diamond (Metric)	21
6.12	High Speed Metal Bond CBN and Diamond	22
6.13	Bottom Grinding Mandrel	23
6.14	Carbide Burr	24
6.15	Special Order Mandrels	25
7.0	Grinding Accessories	26
7.1	Dressing Stick	26
7.2	Wheel Dressers	26
8.0	Additional Information	27
8.1	How to Dress Resin and Metal Bond	27
8.2	Operation	27-28

1.0 How to Order

Call, fax, email or place an order on the Internet using Moore's online shopping feature. Moore Tool accepts all major credit cards.

P (203) 366-3224
F (203) 367-0418
sales@mooretool.com
www.mooretool.com

2.0 Applications Support

Technical abrasive application expertise is available at no cost to all Moore Tool customers. If you have a jig grinding problem, describe the details to us:

- Work piece material
- Work piece hardness
- Type of finish required
- Specific problem

Our grinding wheel specialist will provide recommendations for wheel type, abrasive, grit size, speed and feed rate.

Please contact the Moore Tool Abrasives Department.

(203) 366-3224 or sales@mooretool.com

3.0 Using Grinding Wheels Properly

WARNING – Grinding wheels improperly used can be DANGEROUS!

Do not exceed maximum wheel speeds and observe all safety precautions. Imbalance of mounted abrasive and plated mandrel generates considerable force at high speed. Therefore, each time a wheel is mounted in the spindle, it is important to check the run-out before turning on the air or electric grinding head.

To check wheel run-out, indicate the shank at the closest point to the grinding wheel head while turning the grinding spindle by hand. Run-out should not exceed the following:

Grinding Spindle Type	Maximum T.I.R.
9,000 Air Turbine Grinding Spindle	0.0006" / 0,015 mm
40,000 Air Turbine Grinding Spindle	0.0004" / 0,010 mm
55,000 Air Turbine Grinding Spindle	0.0004" / 0,010 mm
120,000 Turbine Grinding Spindle	0.0003" / 0,007 mm
175,000 Turbine Grinding Spindle	0.0003" / 0,007 mm
15,000 Electric Grinding Spindle	0.0006" / 0,015 mm
40,000 Electric Grinding Spindle	0.0004" / 0,010 mm
80,000 Electric Grinding Spindle	0.0003" / 0,007 mm
ATC Electric Grinding Spindle	0.0004" / 0,010 mm

Grinding Spindle Type	Maximum Wheel Diameter	Maximum Tool Length
9,000 Air Turbine Grinding Spindle	2.5" / 63,5 mm	3.250" / 82,5 mm
40,000 Air Turbine Grinding Spindle	1.5" / 38,1 mm	3.250" / 82,5 mm
55,000 Air Turbine Grinding Spindle	0.750" / 19,0 mm	1.875" / 47,6 mm
120,000 Turbine Grinding Spindle	0.158" / 4,0 mm	0.648 / 16.5 mm
175,000 Turbine Grinding Spindle	0.158" / 4,0 mm	0.648 / 16.5 mm
15,000 Electric Grinding Spindle	2.5" / 63,5 mm	3.250" / 82,5 mm
40,000 Electric Grinding Spindle	1.5" / 38,1 mm	3.250" / 82,5 mm
80,000 Electric Grinding Spindle	0.3125" / 7,9 mm	1.875" / 47,6 mm
ATC Electric Grinding Spindle	1.5" / 38,1 mm	3.250" / 82,5 mm

The grinding wheel must be mounted as rigidly as possible. Deflection of the grinding wheel can have negative effect to cutting efficiency and the life of the mandrel and grinding head. The shorter the overhang of the wheel shank to the wheel head, the less effect of deflection and vibration. In practice, much of the shank of the wheel as possible should be held in the collet (please use caution to ensure the wheel is not "bottomed out" in the collet or spindle). For maximum rigidity, the shortest possible "C" (undercut) dimension and the largest possible "S" (shank diameter) should be used. See figure below.

The same force required to bend Mandrel "X" 0.0005 in. will deflect Mandrel "Y" 0.008 in. The same force will deflect Mandrel "Z" 0.064 in., or 128 times as much as Mandrel "X".

Please refer to and comply with ANSI (American National Standards Institute) safety code, B 7.1 and OSHA covering wheel speeds, safety guards, flanges, mounting procedures, general operating rules, handling, storage and inspection and general machine conditions. Copies of the ANSI Standard can be obtained from the American National Standards Institute. [Http://webstore.ansi.org](http://webstore.ansi.org)

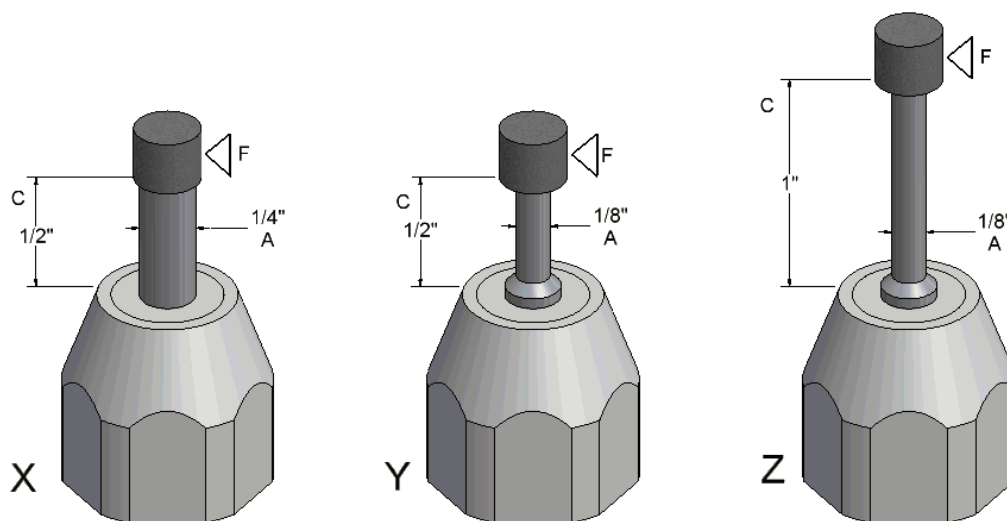

4.0 Abrasive Definitions and Usage

4.1 Conventional Abrasive

Aluminum Oxide (AL2O3) and Silicon Carbide (SiC) abrasive.

- Low cost and easily dressed and trued.
- Shorter wheel life than super abrasives.
- Principle advantage – can be dressed into special configurations for form, radius and angle grinding.

4.2 Electroplate

A single layer of ABN or CBN abrasive that is bonded to the wheel shank with a layer of nickel electroplate.

- Cannot be dressed.
- Least expensive of the super abrasive bond structure with shortest wheel life.

4.3 ABN Super Abrasive (Amber Boron Nitride)

- Recommended for grinding low and high-carbon steels, high-chrome and high-speed tool steels.
 - O Series
 - M Series
 - D Series
 - DA Series
 - Powdered Metals
 - Cast Iron
- Particularly suited for long, uninterrupted cuts common in continuous path jig grinding.
- Aggressive cutting.
- Provides finer surface finish when chop grinding.

4.4 CBN Super Abrasive (Cubic Boron Nitride)

- Many of the same characteristics of ABN Super Abrasives.

4.5 Diamond Super Abrasive

- Recommended for grinding carbides, ferro-ceramics, reinforced resins, sapphire and glass, as well as super-tough alloys.
- Only practical solution for grinding tungsten carbide.
- Particularly suited for long, uninterrupted cuts common in continuous path jig grinding.
- Aggressive cutting.
- Provides finer surface finish when chop grinding.

4.6 Resin Bond

Resin bond combines an epoxy bonding material with the abrasive grains distributed evenly throughout the matrix. As the wheel wears, new abrasive grains are exposed to the work piece.

- Particularly well suited for dry grinding.
- Required periodic dressing and truing.
- Generally not used for aggressive stock removal.

4.7 Metal Bond

Uses a metal filler in a high temperature bond. Abrasive granules are distributed uniformly throughout the matrix.

- Stronger bond than resin and provides better abrasive particle retention.
- Stands up well under aggressive grinding conditions.
- Ideally suited for grinding small holes.
- Superior surface finish.
- Longest lasting super abrasive bond structure and generally most versatile and cost effective.

4.8 Carbide Burr

Diamond pattern end cut.

- Low cost.
- Used for stock removal.
- Soft steels and cast iron.
- Can be coated for longer wheel life.

5.0 Wheel Chart Definitions

- "D" Diameter of the head of the abrasive surface.
- "H" Height of the head of the abrasive surface.
- "C" Undercut.
- "L" Length of the completed shank including "H" dimension.
- "S" Diameter of shank.

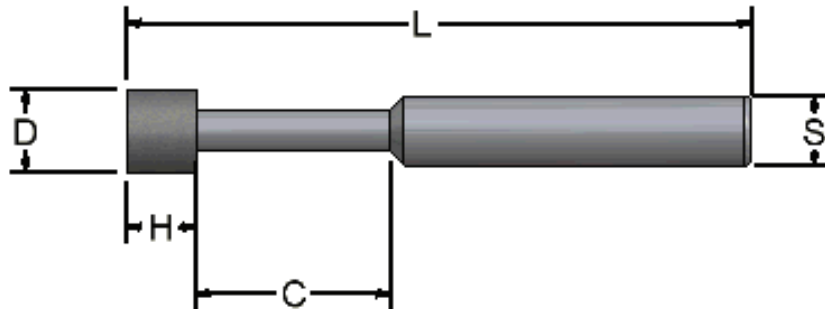

6.0 Grinding Wheel Selection

6.1 Conventional Abrasive

For use with 40K, 55K or 60K R.P.M. Grinding Heads Only.
Recommended for use at 4500 – 6000 S.F.P.M.

Please order by catalog number. All dimensions in inch.				Recommended Use							
				A	A	B	B	C	C	D	D
				Cat.	Part.	Cat.	Part.	Cat.	Part.	Cat.	Part.
D	H	S	L	No.	No.	No.	No.	No.	No.	No.	No.
1/8	1/4	1/8	1 9/16	80039-B	15-1/8-A	SPECIAL	15-1/8-B	80041-B	15-1/8-C	80042-B	15-1/8-D
3/16	1/4	1/8	1 3/4	80043-B	25-3/16-A	SPECIAL	25-3/16-B	80045-B	25-3/16-C	80046-B	25-3/16-D
1/4	1/4	1/8	1 3/4	80047-B	25-1/4-A	80048-B	25-1/4-B	80049-B	25-1/4-C	80050-B	25-1/4-D
1/4	1/4	1/4	3 1/4	80059-B	75-1/4-A	80060-B	75-1/4-B	80061-B	75-1/4-C	80062-B	75-1/4-D
3/8	1/2	1/4	2 1/8	80051-B	35-3/8-A	80052-B	35-3/8-B	80053-B	35-3/8-C	80054-B	35-3/8-D
1/2	1/2	1/4	2 1/8	80055-B	35-1/2-A	80056-B	35-1/2-B	80057-B	35-1/2-C	80058-B	35-1/2-D
3/8	1/2	1/4	3 1/2	80063-B	45-3/8-A	80064-B	45-3/8-B	80065-B	45-3/8-C	80066-B	45-3/8-D
1/2	1/2	1/4	3 1/2	80067-B	45-1/2-A	80068-B	45-1/2-B	80069-B	45-1/2-C	80070-B	45-1/2-D
3/4	1/2	1/4	2 1/8	80071-B	55-3/4-A	80072-B	55-3/4-B	80073-B	55-3/4-C	80074-B	55-3/4-D
1	1/2	1/4	2 1/8	80075-B	55-1-A	80076-B	55-1-B	80077-B	55-1-C	80078-B	55-1-D

- A Cast Iron, Non-Ferrous Metals, Non-Metallics.
- B Soft Construction Steel, Soft Stainless Steel.
- C Tool & Die Steel.
- D Tool & Die Steel, Hardened Construction Steel, Hardened 400S, Stainless Steels.

Note: Wheels available in package lots of 25 only.

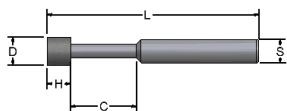

January 2018

For use with 9K or 40K R.P.M. Grinding Heads Only.
Recommended for use at 4500 – 6000 S.F.P.M.

Recommended Use

Please order by catalog number. All dimensions in inch.				A		B		C		D	
				Cat.	Part.	Cat.	Part.	Cat.	Part.	Cat.	Part.
D	H	S	L	No.	No.	No.	No.	No.	No.	No.	No.
¾	½	3/8	4 1/8	80083-B	10-3/4-A	-	-	80084-B	10-3/4-C	80085-B	10-3/4-D
1	½	3/8	4 1/8	80086-B	10-1-A	-	-	80087-B	10-1-C	80088-B	10-1-D
1	½	3/8	2 5/8	80089-B	20-1-A	-	-	80090-B	20-1-C	80091-B	20-1-D
1 ½	½	3/8	2 5/8	80092-B	20-1 ½-A	-	-	80093-B	20-1 ½-C	80094-B	20-1 ½-D
1 ½	½	3/8	3 1/4	80095-B	30-1/2-A	-	-	80096-B	30-1 ½-C	80097-B	30-1 ½-D

- A Cast Iron, Non-Ferrous Metals, Non-Metallics.
- B Tool & Die Steel.
- C Tool & Die Steel, Hardened Construction Steel, Hardened 400S, Stainless Steels.

Note: Wheels available in package lots of 12 only.

Un-mounted Wheels

For use with 9K or 15K R.P.M. Grinding Heads Only.
Recommended for use at 4500 – 6000 S.F.P.M.

Please order by catalog number. All dimensions in inch.			Recommended Use	Cat. No.	Cat. No.
D	H	T			
3	3/8	1/2	Stainless Steel	80098	85-3-A
3	3/8	1/2	General Purpose	80099	85-3-C
3	3/8	1/2	Wear Resistant	80100	85-3-D
Note: Wheels available in package lots of 12 only. To order package, add -B to Catalog Number.					

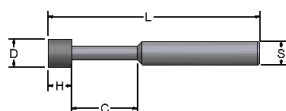
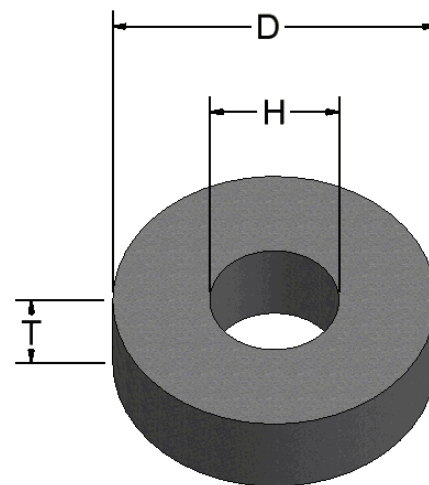

January 2018

6.2 Gold Line

Recommended for use at 4500 – 6000 S.F.P.M.
All dimensions in inch – 60/80 Grit ABN 300.

D	H	S	L	C	Catalog Number
0.250	0.281	¼	3.000	1.000	86050
0.313	0.313	¼	3.000	-	86051
0.375	0.375	3/8	3.000	1.000	86052
0.500	0.375	3/8	3.500	-	86053
0.625	0.375	3/8	3.500	-	86054
0.750	0.375	3/8	3.500	-	86055
1.000	0.375	3/8	3.500	-	86056

Recommended for use at 1370 - 1830 S.M.P.M.
All dimensions in millimeters – 60/80 Grit ABN 300.

D	H	S	L	C	Catalog Number
6	7	6	76	25	86250
8	8	6	76	-	86251
10	10	10	76	25	86252
12.5	10	10	90	-	86253
16	10	10	90	-	86254
19	10	10	90	-	86255
25	10	10	90	-	86256

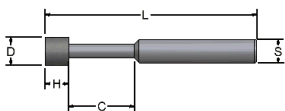

January 2018

6.3 Contour Grinding Mandrels

50 Grit CBN

- Superior Jig Grinding Performance
 - Heavy stock removal designed for chop grinding.
 - Shorter cycle times.
 - Tough blocky crystal structure for long wheel life.
- Recommended Material
 - Tool and Die Steels.
 - High Speed Steels.
 - Cast Iron and High Tech Super Alloys.

D	H	L	S	Catalog Number
.312	¼	3.0	¼	86261
.437	¼	3.5	3/8	86262
.500	¼	3.5	3/8	86263
.625	¼	3.5	3/8	86264
.750	¼	3.5	3/8	86265

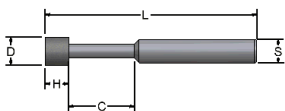
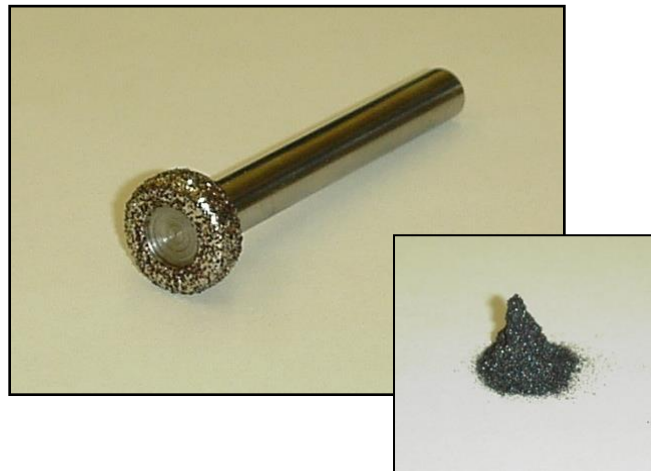

January 2018

6.4 Electroplated CBN and Diamond (Inch)

For use with 40K, 55K, 60K or 80K R.P.M. Grinding Heads Only.
Recommended for use at 4500 – 6000 S.F.P.M.

Please order by catalog number. All dimensions in inch.

D	H	S	L	C	Catalog Number		Catalog Number	
					CBN	CBN	Diamond	Diamond
					Coarse	Medium	Coarse	Medium
					100/120	230/270	80/100	200/240
.029	.079	1/8	2.156	.250	-	85001-BM	-	85101-DM
.039	.079	1/8	2.156	.250	85002-BC	85002-BM	85102-DC	85102-DM
.049	.079	1/8	2.156	.250	85003-BC	85003-BM	85103-DC	85103-DM
.059	.120	1/8	2.156	.500	85041-BC	85041-BM	85141-DC	85141-DM
.069	.118	1/8	2.156	.500	85004-BC	85004-BM	85104-DC	85104-DM
.079	.160	1/8	2.156	.500	85042-BC	85042-BM	85142-DC	85142-DM
.089	.157	1/8	2.156	.500	85005-BC	85005-BM	85105-DC	85105-DM
.099	.157	1/8	2.156	.500	85043-BC	85043-BM	85143-DC	85143-DM
.109	.157	1/8	2.156	.500	85006-BC	85006-BM	85106-DC	85106-DM
.118	.157	1/8	2.156	.625	85044-BC	85044-BM	85144-DC	85144-DM
.130	.197	1/8	2.156	.625	85007-BC	85007-BM	85107-DC	85107-DM
.140	.197	1/8	2.156	-	85045-BC	85045-BM	85145-DC	85145-DM
.157	.197	1/8	2.156	-	85008-BC	85008-BM	85108-DC	85108-DM
.177	.236	1/8	2.156	-	85009-BC	85009-BM	85109-DC	85109-DM
.197	.236	1/8	2.156	-	85010-BC	85010-BM	85110-DC	85110-DM
.197	.250	3/16	3.000	1.000	100749-BC	100749-BM	-	-
.215	.236	1/4	3.000	1.000	85046-BC	85046-BM	85146-DC	85146-DM
.215	.250	3/16	3.000	-	100750-BC	100750-BM	-	-
.236	.275	1/4	3.000	1.000	85012-BC	85012-BM	85112-DC	85112-DM
.236	.275	3/16	3.000	-	100751-BC	100751-BM	-	-
.256	.275	1/4	3.000	1.000	85013-BC	85013-BM	85113-DC	85113-DM
.275	.315	1/4	3.000	-	85047-BC	85047-BM	85147-DC	85147-DM
.315	.315	1/4	3.000	-	85014-BC	85014-BM	85114-DC	85114-DM
.335	.315	1/4	3.000	-	85015-BC	85015-BM	85115-DC	85115-DM
.394	.394	3/8	3.500	-	85017-BC	85017-BM	84117-DC	85117-DM
.473	.394	3/8	3.500	-	85019-BC	85019-BM	85119-DC	85119-DM
.500	.394	3/8	3.500	-	85048-BC	85048-BM	85148-DC	85148-DM
.591	.394	3/8	3.500	-	85021-BC	85021-BM	85121-DC	85121-DM

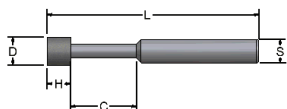

January 2018



.730	.394	3/8	3.500	-	85023-BC	85023-BM	85123-DC	85123-DM
1.000	.394	3/8	3.500	-	85024-BC	85024-BM	85124-DC	85124-DM

6.5 Electroplated CBN and Diamond (Metric)

For use with 40K, 55K, 60K or 80K R.P.M. Grinding Heads Only.
Recommended for use at 1370 – 1830 S.M.P.M.

Please order by catalog number. All dimensions in millimeters.

D	H	S	L	C	Catalog Number		Catalog Number	
					CBN	CBN	Diamond	Diamond
					Coarse	Medium	Coarse	Medium
					100/120	230/270	80/100	200/240
0,8	2,0	3,0	55,0	6,35	-	85201-BM	-	85301-DM
1,0	2,0	3,0	55,0	6,35	85202-BC	85202-BM	85302-DC	85302-DM
1,3	2,0	3,0	55,0	6,35	85203-BC	85203-BM	85303-DC	85303-DM
1,8	3,0	3,0	55,0	12,70	85204-BC	85204-BM	85304-DC	85304-DM
2,3	4,0	3,0	55,0	12,70	85205-BC	85205-BM	85305-DC	85305-DM
2,8	4,0	3,0	55,0	12,70	85206-BC	85206-BM	85306-DC	85306-DM
3,3	5,0	3,0	55,0	15,90	85207-BC	85207-BM	85307-DC	85307-DM
4,0	5,0	3,0	55,0	-	85208-BC	85208-BM	85308-DC	85308-DM
4,5	6,0	3,0	55,0	-	85209-BC	85209-BM	85309-DC	85309-DM
5,0	6,0	3,0	55,0	-	85210-BC	85210-BM	85310-DC	85310-DM
6,0	7,0	6,0	77,0	25,40	85212-BC	85212-BM	85312-DC	85312-DM
6,5	7,0	6,0	77,0	-	85213-BC	85213-BM	85313-DC	85313-DM
8,0	8,0	6,0	77,0	-	85214-BC	85214-BM	85314-DC	85314-DM
10,0	10,0	10,0	89,0	-	85230	-	85330	-
12,0	10,0	10,0	89,0	-	85231	-	85331	-
15,0	10,0	10,0	89,0	-	85232	-	85332	-
18,5	10,0	10,0	89,0	-	85233	-	Special Order	-
25,4	10,0	10,0	89,0	-	85234	-	85334	-

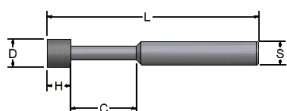

January 2018

6.6 High Speed Electroplated CBN and Diamond (Inch)

For use with 120K or 175K R.P.M. Grinding Heads Only.
Recommended for use at 4000 – 6000 S.F.P.M.

Please order by catalog number. All dimensions in inch.

D	H	S	L	C	Catalog Number		Catalog Number	
					CBN	CBN	Diamond	Diamond
					Coarse	Medium	Coarse	Medium
					120/140	230/270	120/140	230/270
.018	.078	1/8	7/8	.108	-	85400-BM	-	85600-DM
.024	.078	1/8	29/32	.145	-	85401-BM	-	85601-DM
.030	.078	1/8	15/16	.190	-	85402-BM	-	85602-DM
.035	.094	1/8	31/32	.218	-	85403-BM	-	85603-DM
.040	.094	1/8	1	.240	85404-BC	85404-BM	85604-DC	85604-DM
.050	.125	1/8	1 – 1/16	.312	85405-BC	85405-BM	Special Order	85605-DM
.060	.125	1/8	1 – 1/8	.375	85406-BC	85406-BM	85606-DC	85606-DM
.070	.156	1/8	1 – 3/16	.437	85407-BC	85407-BM	85607-DC	85607-DM
.079	.156	1/8	1 – ¼	.500	85408-BC	85408-BM	85608-DC	85608-DM
.090	.156	1/8	1 – ¼	.500	85409-BC	85409-BM	85609-DC	85609-DM
.100	.156	1/8	1 – ¼	.500	85410-BC	85410-BM	85610-DC	85610-DM
.110	.188	1/8	1 – ¼	.500	85411-BC	85411-BM	85611-DC	85611-DM
.118	.188	1/8	1 – ¼	.500	85412-BC	85412-BM	85612-DC	85612-DM
.135	.188	1/8	1 – ¼	-	85413-BC	85413-BM	85613-DC	Special Order
.158	.188	1/8	1 – ¼	-	Special Order	85414-BM	85614-DC	85614-DM

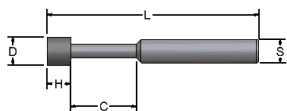

January 2018

6.7 High Speed Electroplated CBN and Diamond (Metric)

For use with 120K or 175K R.P.M. Grinding Heads Only.
Recommended for use at 1370 – 1830 S.M.P.M.

Please order by catalog number. All dimensions in millimeters.

					Catalog Number		Catalog Number	
					CBN	CBN	Diamond	Diamond
					Coarse	Medium	Coarse	Medium
D	H	S	L	C	120/140	230/270	120/140	230/270
0,5	2,0	3,0	22,2	2,74	-	85500-BM	-	85700-DM
0,6	2,0	3,0	23,0	3,68	-	85501-BM	-	85701-DM
0,8	2,0	3,0	23,8	4,83	-	85502-BM	-	85702-DM
0,9	2,4	3,0	24,6	5,54	-	85503-BM	-	85703-DM
1,0	2,4	3,0	25,4	6,10	85504-BC	85504-BM	85704-DC	Special Order
1,2	3,17	3,0	26,97	7,9	85505-BC	85505-BM	85705-DC	Special Order
1,5	3,17	3,0	28,6	9,5	85506-BC	85506-BM	85706-DC	85706-DM
1,8	4,0	3,0	30,15	11,1	85507-BC	85507-BM	85707-DC	85707-DM
2,0	4,0	3,0	31,75	12,7	85508-BC	85508-BM	85708-DC	85708-DM
2,3	4,0	3,0	31,75	12,7	85509-BC	85509-BM	85709-DC	Special Order
2,5	4,0	3,0	31,75	12,7	85510-BC	85510-BM	85710-DC	85710-DM
2,8	4,78	3,0	31,75	12,7	85511-BC	85511-BM	85711-DC	Special Order
3,0	4,78	3,0	31,75	12,7	85512-BC	85512-BM	85712-DC	85712-DM
3,4	4,78	3,0	31,75	-	85513-BC	85513-BM	85713-DC	Special Order
4,0	4,78	3,0	31,75	-	85514-BC	85514-BM	85714-DC	Special Order

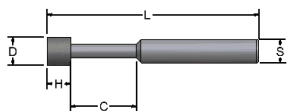

January 2018

6.8 Resin Bond CBN and Diamond (Inch)

For use with 40K, 55K, 60K or 80K R.P.M. Grinding Heads Only.
Recommended for use at 4500 – 6000 S.F.P.M.

Please order by catalog number. All dimensions in inch.

					Catalog Number		Catalog Number	
					CBN	CBN	Diamond	Diamond
					Coarse	Medium	Coarse	Medium
D	H	S	L	C	150	220	120	180
.090	.187	1/8	2 3/16	5/16	85050-BC	85050-BM	85150-DC	Special Order
.125	.187	1/8	2 3/16	5/16	85051-BC	85051-BM	85151-DC	85151-DM
.156	.187	1/8	2 3/16	3/8	85052-BC	85052-BM	85152-DC	85152-DM
.187	.187	1/8	2 3/16	3/8	85053-BC	85053-BM	85153-DC	85153-DM
.250	.250	1/4	3	7/8	85054-BC	85054-BM	85154-DC	85154-DM
.312	.250	1/4	3	7/8	85055-BC	85055-BM	85155-DC	85155-DM
.375	.250	1/4	3 1/8		85056-BC	85056-BM	85156-DC	85356-DM
.437	.250	1/4	3 1/8	7/8	85057-BC	85057-BM	85157-DC	85157-DM
.500	.250	1/4	3 1/8	7/8	85058-BC	85058-BM	85158-DC	85158-DM
.625	.250	3/8	3 1/2	7/8	85059-BC	85059-BM	85159-DC	85159-DM
.750	.250	3/8	3 1/2	7/8	85060-BC	85060-BM	85160-DC	85160-DM
1.000	.250	3/8	3 1/2	7/8	85061-BC	85061-BM	85161-DC	85161-DM

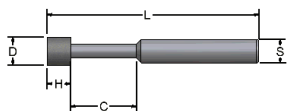

January 2018

6.9 Resin Bond CBN and Diamond (Metric)

For use with 40K, 55K, 60K or 80K R.P.M. Grinding Heads Only.
Recommended for use at 1370 – 1830 S.M.P.M.

Please order by catalog number. All dimensions in millimeters.

					Catalog Number		Catalog Number	
					CBN	CBN	Diamond	Diamond
					Coarse	Medium	Coarse	Medium
D	H	S	L	C	150	220	120	180
2,3	4,7	3,0	55,5	7,9	85250-BC	Special Order	85350-DC	85350-DM
3,2	4,7	3,0	55,5	7,9	85251-BC	85251-BM	Special Order	85351-DM
4,0	4,7	3,0	55,5	9,5	85252-BC	85252-BM	Special Order	85352-DM
4,7	4,7	3,0	55,5	9,5	85253-BC	85253-BM	85353-DC	85353-DM
6,4	6,4	6,0	76,2	22, 2	85254-BC	85254-BM	Special Order	85354-DM
7,9	6,4	6,0	76,2	22,2	85255-BC	85255-BM	85355-DC	85355-DM
9,5	6,4	6,0	79,4	22,2	85256-BC	85256-BM	85356-DC	85356-DM
11,1	6,4	6,0	79,4	22,2	Special Order	Special Order	85357-DC	Special Order
12,7	6,4	6,0	79,4	22,2	85258-BC	85258-BM	85358-DC	Special Order
15,9	6,4	10,0	95,2	-	85280-BC	85280-BM	85380-DC	85380-DM
19,0	6,4	10,0	95,2	-	85281-BC	85281-BM	Special Order	85381-DM
25,4	6,4	10,0	95,2	-	85282-BC	85282-BM	85382-DC	85382-DM

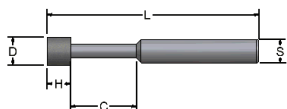

January 2018

6.10 Metal Bond CBN and Diamond (Inch)

For use with 40K, 55K, 60K or 80K R.P.M. Grinding Heads Only.
Recommended for use at 2000 – 4000 S.F.P.M.

Please order by catalog number. All dimensions in inch.

					Catalog Number		Catalog Number	
					CBN	CBN	Diamond	Diamond
					Coarse	Medium	Coarse	Medium
D	H	S	L	C	100	150	100	150
.125	.187	1/8	2.000	1.000	-	50608	-	50708
.156	.187	1/8	2.000	-	-	50609	-	50709
.187	.125	1/8	2.000	-	-	50610	-	50710
.187	.250	3/16	2.500	-	-	100738	-	Special Order
.250	.125	1/8	2.000	-	-	50611	-	50711
.250	.250	3/16	2.500	-	-	100739	-	Special Order
.281	.250	1/8	2.000	-	-	50612	-	50712
.281	.250	3/16	2.500	-	-	100740	-	Special Order
.312	.250	¼	2.000	-	-	50613	-	50713
.375	.250	¼	2.500	-	50614	-	50714	-
.437	.375	3/8	3.000	-	50615	-	50715	-
.500	.375	3/8	3.000	-	50616	-	50716	-

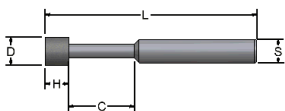

January 2018

6.11 Metal Bond CBN and Diamond (Metric)

For use with 40K, 55K, 60K or 80K R.P.M. Grinding Heads Only.
Recommended for use at 610 – 1220 S.M.P.M.

Please order by catalog number. All dimensions in millimeters.

					Catalog Number		Catalog Number	
					CBN	CBN	Diamond	Diamond
					Coarse	Medium	Coarse	Medium
D	H	S	L	C	100	150	100	150
3,2	4,7	3,0	50,8	25,4	-	85550	-	85650
4,0	4,7	3,0	50,8	-	-	85551	-	85651
4,7	3,1	3,0	50,8	-	-	85552	-	85652
6,4	3,1	3,0	50,8	-	-	Special Order	-	85653
7,1	6,4	3,0	50,8	-	-	Special Order	-	Special Order
7,9	6,4	6,0	50,8	-	-	85555	-	85655
9,5	6,4	6,0	63,5	-	85556	-	85656	-
11,1	9,5	10,0	76,2	-	Special Order	-	85657	-
12,7	9,5	10,0	76,2	-	85558	-	85658	-

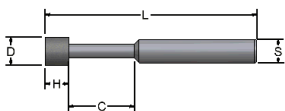

January 2018

6.12 High Speed Metal Bond CBN and Diamond

For use with 120K or 175K R.P.M. Grinding Heads Only.
Recommended for use at 2000 – 4000 S.F.P.M.

Please order by catalog number. All dimensions in inch.					Catalog Number	
					CBN	Diamond
					Grit Size	Grit Size
D	H	S	L	C	180	180
.030	.093	1/8	.937	.180	50600	Special Order
.035	.093	1/8	.968	.210	50601	50701
.040	.093	1/8	1.000	.240	50602	50702
.050	.093	1/8	1.062	.300	50603	50703
.060	.093	1/8	1.125	.360	50604	50704
.070	.093	1/8	1.187	.420	50605	50705
.080	.093	1/8	1.250	.480	50606	50706
.090	.093	1/8	1.250	.540	50607	50707

For use with 120K or 175K R.P.M. Grinding Heads Only.
Recommended for use at 610 – 1220 S.M.P.M.

Please order by catalog number. All dimensions in millimeters.					Catalog Number	
					CBN	Diamond
					Grit Size	Grit Size
D	H	S	L	C	180	180
0,8	2,4	3,0	23,8	4,57	50800	50900
0,9	2,4	3,0	24,6	5,33	50801	50901
1,0	2,4	3,0	25,4	6,09	50802	50902
1,3	2,4	3,0	27,0	7,62	50803	50903
1,5	2,4	3,0	28,5	9,14	50804	50904
1,8	2,4	3,0	30,1	10,7	50805	50905
2,0	2,4	3,0	31,8	12,2	50806	50906
2,3	2,4	3,0	31,8	13,7	50807	50907

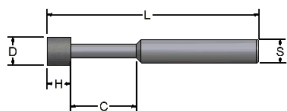

January 2018

6.13 Bottom Grinding Mandrel

For use with 40K, 55K, 60K or 80K R.P.M. Grinding Heads Only.

Please order by catalog number. All dimensions in inch.					Catalog Number
					ABN
					Grit Size
D	H	S	L	C	60/80
.250	.125	¼	2.000	1.000	74142
.375	.125	3/8	2.000	1.000	74143
.500	.125	3/8	2.500	-	74144
.625	.125	3/8	2.500	-	74145
.750	.125	3/8	2.500	-	74146
1.000	.125	3/8	2.500	-	74147

For use with 40K, 55K, 60K or 80K R.P.M. Grinding Heads Only.

Please order by catalog number. All dimensions in millimeters.					Catalog Number
					ABN
					Grit Size
D	H	S	L	C	60/80
6,0	3,0	6,0	50,8	25,4	85750
10,0	3,0	10,0	50,8	25,4	85751
12,7	3,0	10,0	63,5	-	85752
15,8	3,0	10,0	63,5	-	85753
19,0	3,0	10,0	63,5	-	85754
24,4	3,0	10,0	63,5	-	85755

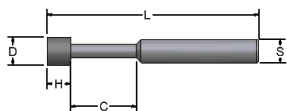

January 2018

6.14 Carbide Burr

For use with 40K, 55K, 60K or 80K R.P.M. Grinding Heads Only.

Please order by catalog number. All dimensions in inch.

D	H	S	L	C	Catalog Number
.125	.188	1/8	1.500	.500	100741
.156	.188	3/16	2.000	.625	100742
.188	.250	3/16	2.000	.625	100743
.219	.281	¼	2.000	.750	100744
.250	.313	¼	2.000	.750	100745
.313	.344	¼	2.500	-	100746
.375	.375	¼	2.500	-	100747
.500	.375	3/8	3.500	-	100748

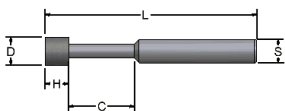

January 2018

6.15 Please use this form when ordering special wheels.

P (203) 366-3224
F (203) 367-0418
sales@mooretool.com
www.sales@mooretool.com

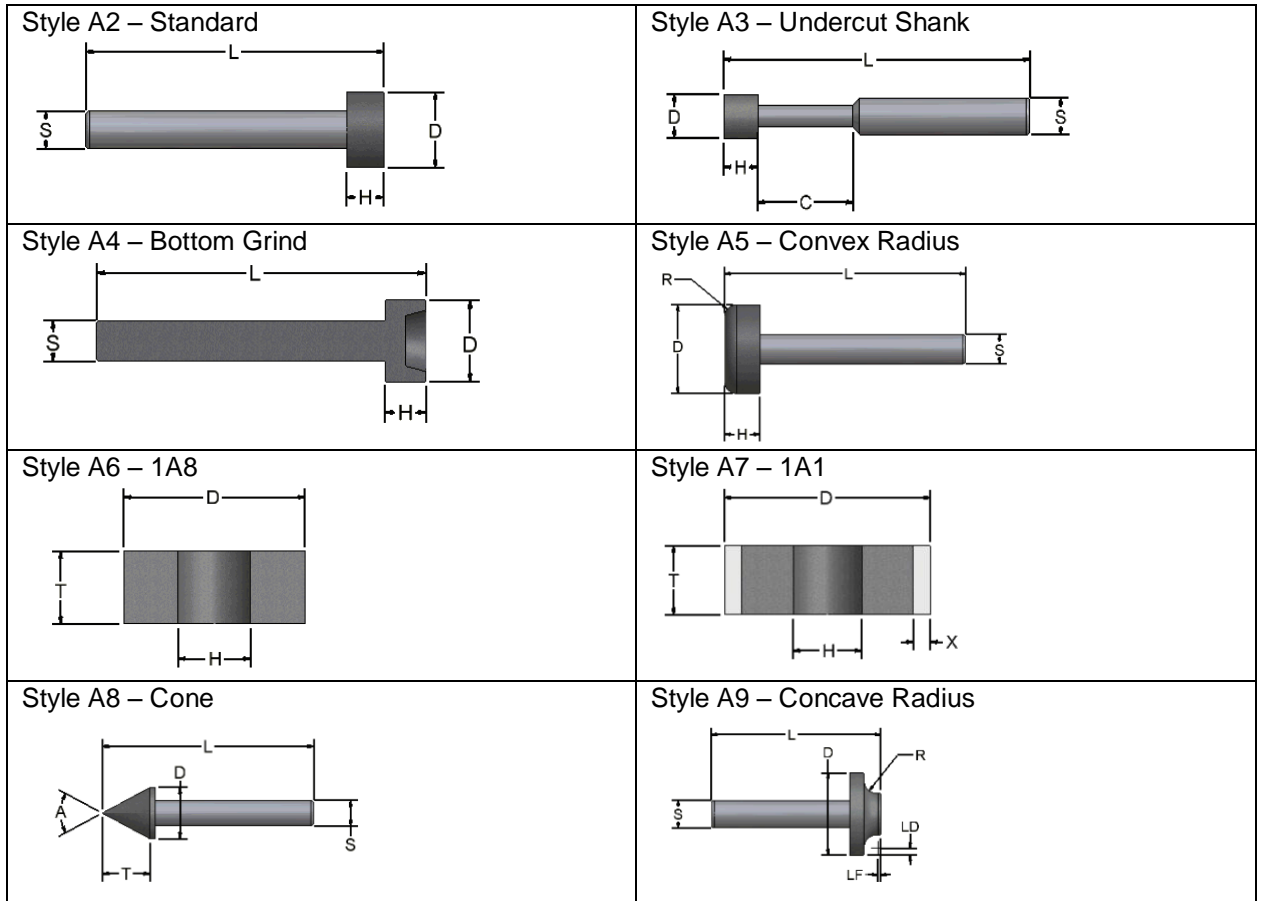

“D”	“T”	“S”	“C”	“H”	“L”
“UL”	“A”	“R”	“LF”	“LD”	“LD”

Quantity:	<input type="text"/>	Diamond:	<input type="text"/>	Plated:	<input type="text"/>	VM:	<input type="text"/>
Style:	<input type="text"/>	CBN:	<input type="text"/>	Resin:	<input type="text"/>	Vitrified:	<input type="text"/>
		Grit Size:	<input type="text"/>	Metal:	<input type="text"/>		

7.0 Grinding Accessories

7.1 Dressing Stick

Catalog Number	Application
82152	Dressing CBN and Diamond resin bond grinding mandrels.
55761	Dressing CBN metal bond grinding mandrels.
55762	Dressing Diamond metal bond grinding mandrels.
59891	Dressing and truing aluminum oxide and silicon carbide.
80400	Cleaning electroplated super abrasive grinding mandrels.
2537	Boron carbide for dressing vitrified wheels up to 10 inch in diameter, grade M and softer.

7.2 Wheel Dresser

Catalog Number	Name
G500-680-310	Dresser Assembly, Rotary DTS-1300
102775	Standard Dressing Wheel
102776-M	Dressing Wheel - Pointed
2656-A	Hand Held Dresser
2657	Replacement Diamond
80030	Magnetic Base Dresser
2657	Replacement Diamond
80031	Angle Type Dresser
80032	Replacement Diamond
73416	Diamond Nib

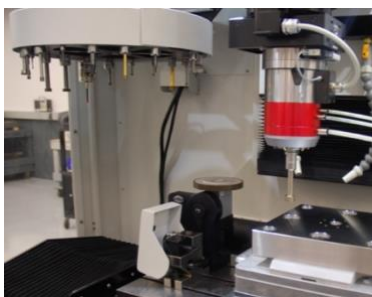

1.1..... Model DTS 1300 - Variable Speed Dressing Unit

- Dressing and truing of grinding wheels.
- Dressing forms and shapes into grinding wheels.
- RPM range 230 Vac. Drive: 1,000 to 12,000.
- Flood Coolant Ready.
- Simple controls with a compact design.
- Spindle run out 0.00005 (1.3 Micron).

Please visit the Internet at www.mooretool.com or the Moore Jig Grinding Accessories catalog for a full list of accessories offered by Moore Tool.

8.0 Additional Information

8.1 How to Dress Resin and Metal Bond

Resin and metal bond super abrasive mandrels must be periodically trued. The truing operation feeds the super abrasive mandrel past the truing tool. Feed rate should be 30 to 40 inches per minute (0,75 – 1 meters per minute) per pass. Always apply coolant during the dressing cycle. Truing tends to glaze resin and metal bond super abrasive mandrels. Therefore, it is necessary to dress the mandrel to re-expose the sharp edge of the crystal. A Moore Tool dressing stick should be saturated with water and then fed into the rotating wheel. As the stick is consumed, the bonded material is removed and the crystals are exposed. As the stick consumption rate accelerates and then levels off, it can be assumed that the mandrel is ready for grinding.

8.2 Operation

Formula for determining R.P.M. (Revolutions Per Minute).

Inch: R.P.M. = S.F.P.M. (Surface Feet Per Minute) times 3.82 divided by the wheel head diameter in inches.

Metric: R.P.M. = S.M.P.M. (Surface Meters Per Minute) times 318 divided by the wheel head diameter in millimeters.

Formula for determining S.F.P.M. and S.M.P.M.

Inch: S.F.P.M. = R.P.M. of the grinding head times the wheel head diameter divided by 3.82.

Metric: S.M.P.M. = R.P.M. of the grinding head times the wheel head diameter divided by 318.

Recommended speeds by abrasive type:

S.F.P.M.	S.M.P.M.	Abrasive Type
4500 - 6000	1370 – 1830	Electroplated ABN, CBN and Diamond. Resin Bond CBN and Diamond.
2000 - 4000	610 - 1220	Metal Bond CBN and Diamond

Inch Air Pressure	Metric Air Pressure	9K R.P.M.	40K R.P.M.	55K R.P.M.	60K R.P.M.	120K R.P.M.	175K R.P.M.
PSI	BAR	Approximate R.P.M.	Approximate R.P.M.	Approximate R.P.M.	Approximate R.P.M.	Approximate R.P.M.	Approximate R.P.M.
30	2.0	-	16,000	-	-	X	X
40	2.7	-	19,400	-	-	X	X
50	3.4	6,000	23,000	37,000	41,500	X	X
60	4.1	7,300	26,400	41,000	46,000	117,000	150,000
70	4.8	8,000	29,700	45,000	48,000	-	-
80	5.4	8,750	33,200	49,000	51,300	125,000	165,000
90	6.1	9,250	36,300	51,000	56,200	-	-
100	6.8	9,700	40,000	55,000	60,000	134,000	175,000

Warning: Do not operate 120,000 and 175,000 R.P.M. grinding heads at less than 60 PSI (4.1 BAR).